

# ***OWNER'S OPERATING & INSTALLATION MANUAL***

**PS2020 Series Electric Ovens  
PS2620 Series Electric Ovens**

**Combinations:**

- Single Oven
- Double-Stacked Oven



*The information contained in this manual is important for the proper installation, use, maintenance, and repair of this oven. Follow these procedures and instructions to help ensure satisfactory baking results and years of trouble-free service.*

*Errors – descriptive, typographic, or pictorial – are subject to correction. Specifications are subject to change without notice.*

*This Owner's Operating and Installation Manual should be given to the user. The operator of the oven should be familiar with the function and operation of the oven. This manual must be kept in a prominent, easily reachable location near the oven.*

*Middleby Marshall suggests a service contract with a Middleby Authorized Service Agent (ASA).*

*Please carefully read this manual and retain it for future reference.*

*For further information, call*

877-34-OVENS

or

877-346-8367

*This page intentionally  
left blank*



# Table of Contents

## Safety Information

Important Safety Information - Please Read First	i
General Safety Information	i
Reducing Fire Risk	ii
Preventing Oven Damage	ii
Grounding Instructions	ii
Power Cord Replacement	ii

## Specifications and Installation

PS2020 Dimensions	1
PS2020 Electrical Specifications	1
PS2620 Dimensions	2
PS2620 Electrical Specifications	2
Packaging	3
Certifications	3
Construction	3
Installation Instructions	3
Delivery and Initial Inspection	3
Lifting the Oven	3
Oven Location and Placement	3
Installation Near Open Heat Source	4
Ventilation Requirements	4

## Cleaning

Daily Cleaning Instructions	5
Weekly Cleaning Instructions	6-8

## Standard Oven Operation

Oven Controls	9
Cooking	10-11
Editing a Cooking Profile	12
Changing a Cooking Profile Name	12
Adjusting the Belt Speed	13
Adjusting the Temperature	13

Adjusting the Top and Bottom Air	13
<b>Oven Modes</b>	
Config Mode	14
Smart Card Screen (Loading a Menu)	14
Accessing the Fault Count Screen	14
Accessing the Setup Mode	14
Setup Mode	14
Changing the Display Temperature	15
Changing the Belt Direction	15
Edit Options Screen	15
Changing the Speaker Volume	16
Info Screen	16
Updating the Firmware	16
<b>Troubleshooting</b>	17-18
Replaceable Parts	19
<b>North America Limited Warranty</b>	20-22
<b>International Limited Warranty</b>	23-26

## Important Safety Information – Please Read First

Improper installation, adjustment, alteration, service, or maintenance of this equipment can cause property damage, injury, or death. Thoroughly read the installation, operating, and maintenance instructions before installing or servicing this equipment. Strictly adhere to the following safety information to reduce the risk of:

- Damage to the oven
- Damage to property near the oven
- Personal injury
- Burns
- Fire
- Electric shock

## General Safety Information

- Use this appliance only for its intended uses as described in this manual.
- Only qualified service personnel should service this appliance. Contact the nearest authorized service facility for examination, repair, or adjustment. Visit [www.middlebymarshall.com](http://www.middlebymarshall.com) to find your nearest Authorized Service Agent.
- Always ensure the oven is disconnected from the power supply before servicing, repairing, or adjusting any components or parts.
- This appliance is not intended for use by persons (including children) with reduced physical, sensory or mental capabilities, or lack of experience and knowledge, unless they have been given supervision or instruction concerning use of the appliance by a person responsible for their safety.
- The equipment warranty is not valid unless the oven is installed, started, and demonstrated under the supervision of a factory certified installer.
- The equipment is only for professional use and shall be used by qualified personnel.
- DO NOT place the cord near heated surfaces.
- DO NOT store or use flammable vapors or liquids (e.g., gasoline) in the vicinity of this appliance.
- DO NOT allow children to use this appliance. Children should be supervised to ensure that they do not play with the appliance
- DO NOT place corrosive chemicals or vapors in this appliance. It is not designed for industrial or laboratory use.
- DO NOT Operate this appliance if it:
  - Has a damaged cord or plug
  - Is not working properly
  - Has been damaged or dropped
- DO NOT cover or block any openings on this appliance.
- DO NOT store this appliance outdoors.
- DO NOT use this appliance near water.
- DO NOT immerse this appliance or any of its components (e.g., cord, plug, etc.) in water.
- DO NOT let the cord hang over the edge of a table or counter.

## Reducing Fire Risk

If materials inside the oven ignite or if smoke is observed,

1. Turn off the oven.
  2. Disconnect the power cord or shut off power at the fuse/circuit breaker panel.
- Carefully attend the oven if paper, plastic, or other combustible materials are placed inside the oven to facilitate cooking.
  - DO NOT leave items in the cook cavity when the oven is not in use.
  - DO NOT cook items wrapped in cling wrap or plastic film.
  - DO NOT overcook food.

## Preventing Oven Damage

- When servicing this appliance, do not tear insulation to get to components. Rather, find the edge of the insulation and remove the tape that holds it in place.
- Clean the oven daily.
- Clean the oven only with approved cleaner.
- DO NOT clean with a water jet.
- DO NOT allow cleaning solution or water to remain in the cook cavity longer than necessary.

## Grounding Instructions

 **WARNING:** Improper grounding increases the risk of electric shock.

This appliance must be grounded. The cord is equipped with a grounding wire and plug, which in the event of an electrical short circuit, reduce the risk of electric shock by providing an escape wire for the electric current. The wire must be plugged into an outlet that is properly installed and grounded.

Consult a qualified electrician or serviceman to determine whether or not the appliance is properly grounded.

- DO NOT use an extension cord. If the power supply cord is too short, request a qualified electrician or serviceman to install an outlet near the appliance.

## Power Cord Replacement

To avoid potential hazards, only the manufacturer, its service agent, or a similarly-qualified person should replace a damaged power cord.

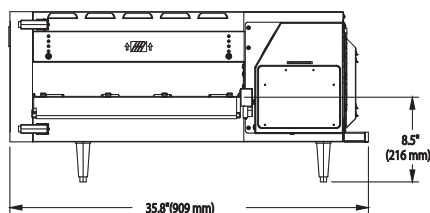

Figure 1: PS2020 Oven Dimensions – Side

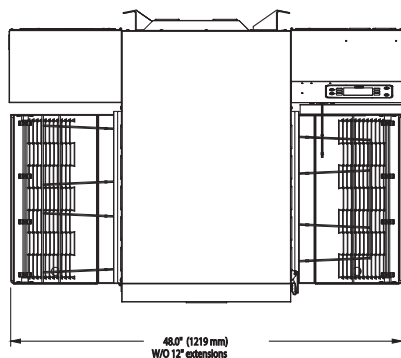

Figure 2: PS2020 Oven Dimensions – Top

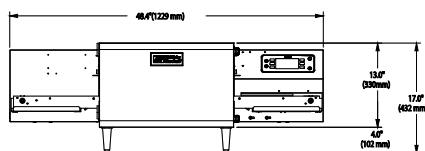

Figure 3: PS2020 Oven Dimensions – Front (Single)

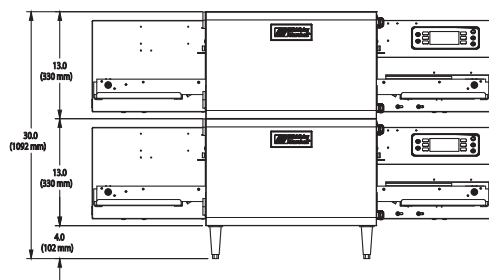

Figure 4: PS2020 Oven Dimensions – Front (Double)

## PS2020 Dimensions

### Exterior

Height	13.0" (330 mm)
with legs	17.0" (432 mm)
Width	48.0" (1219 mm)
Depth	35.8" (909 mm)

### Conveyor

Length	48.0" (1219 mm)
Width	20.0" (508 mm)

## Electrical Specifications

### North America

3 Phase  
 208/240 VAC  
 50/60 Hz  
 40 amp current draw  
 Max Input: 14.4 kW  
 4-wire supply  
 NEMA 15-50P plug (4-pin IEC60309 available by special order)  
 50-amp max circuit breaker protection

### Europe/Asia (220-240 VAC)

3 Phase  
 220-240 VAC  
 50/60 Hz  
 40 amp current draw  
 Max Input: 14.4 kW  
 4-wire supply  
 IEC60309 4-pin plug  
 64-amp max circuit breaker protection

### Europe/Asia (380-415 VAC)

3 Phase  
 380-415 VAC  
 50/60 Hz  
 20 amp current draw  
 Max Input: 14.4 kW  
 5-wire supply  
 IEC60309 5-pin plug  
 32-amp max circuit breaker protection

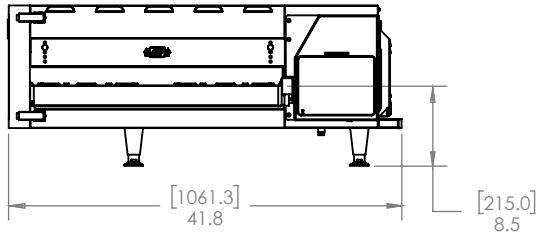

Figure 1: PS2620 Oven Dimensions – Side

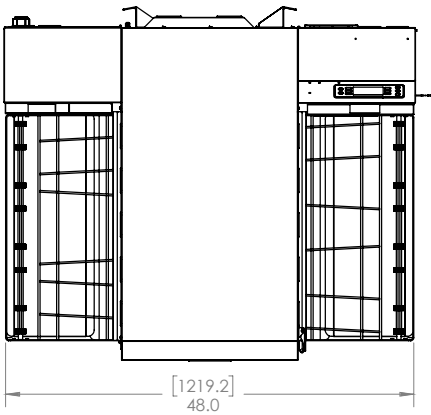

Figure 2: PS2620 Oven Dimensions – Top

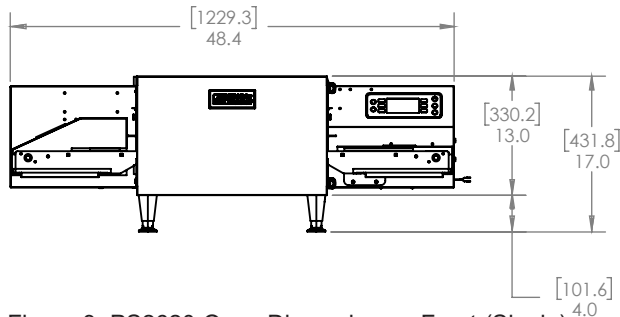

Figure 3: PS2620 Oven Dimensions – Front (Single)

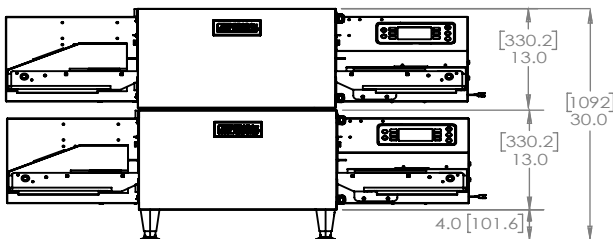

Figure 4: PS2620 Oven Dimensions – Front (Double)

## PS2620 Dimensions

### Exterior

Height	13.0" (330 mm)
with legs	17.0" (432 mm)
Width	48.0" (1219 mm)
Depth	35.8" (909 mm)

### Conveyor

Length	48.0" (1219 mm)
Width	26.0" (660 mm)

## Electrical Specifications

### North America

- 3 Phase
- 208/240 VAC
- 50/60 Hz
- 40 amp current draw
- Max Input: 14.4 kW
- 4-wire supply
- NEMA 15-50P plug (4-pin IEC60309 available by special order)
- 50-amp max circuit breaker protection

### Europe/Asia (220-240 VAC)

- 3 Phase
- 220-240 VAC
- 50/60 Hz
- 40 amp current draw
- Max Input: 14.4 kW
- 4-wire supply
- IEC60309 4-pin plug
- 64-amp max circuit breaker protection

### Europe/Asia (380-415 VAC)

- 3 Phase
- 380-415 VAC
- 50/60 Hz
- 20 amp current draw
- Max Input: 14.4 kW
- 5-wire supply
- IEC60309 5-pin plug
- 32-amp max circuit breaker protection

## Packaging

All ovens are packaged in a double-wall corrugated box with integrated wooden skids. All international ovens shipped via Air or Less than Container Loads are packaged in wooden crates.

## Certifications





## Construction

- 430 stainless steel front, top, sides, and back
- Cool to touch covers and panels
- Stainless steel interior
- 20-inch-wide cook chamber

## Installation Instructions

The oven is designed and certified for safe operation when installed in accordance with local and/or national codes. It is the owner and/or installer's responsibility to comply with any codes that may exist. Install this oven according to the policies and procedures outlined below and throughout this manual.

 **WARNING:** Death, injury, and equipment damage can result from improper installation of a unit damaged during shipment or storage.

 **WARNING:** Do not install an oven suspected of damage. Improper installation or the installation of a unit damaged during shipment or storage may void the Limited Warranty.

## Delivery and Initial Inspection

All Middleby Marshall ovens are shipped so as to prevent damage.

Upon delivery, inspect the shipping container for external damage. Any evidence of damage should be noted on the delivery receipt which must be signed by the driver.

Upon removing the oven from its shipping carton, check for damage. Make note of any damage and contact the shipping company to file a claim. Carriers will accept claims for concealed damage if notified within fifteen days of the delivery and if the shipping container is retained for inspection.

Middleby Marshall does not assume responsibility for any loss or damage suffered in transit. The carrier assumes full responsibility for delivery in good order when the shipment is accepted. However, when necessary, Middleby Marshall can assist in filing a claim.

## Lifting the Oven

 **WARNING:** Two or more people are required to lift the the PS2020 (195 lb. ((88.5 kg))) and PS2620 (260 lb. ((118 kg))).

Position one or more people on either side of the oven. Lift from the bottom. Never lift the oven from the front and rear. The countertop must be at least 30" (762 mm) deep and capable of supporting 200 lb. (90.7 kg) for the PS2020 and 265 lb. (118 kg) for the PS2620.

Once properly positioned on the counter, plug the oven into a wall mounted electrical receptacle. See Electrical Specifications on page 1 for the PS2020, page 2 for the PS2620.

## Oven Location and Placement

 **WARNING:** Death, injury and equipment damage may result from improper positioning.

 **WARNING:** DO NOT stack ovens without stacking brackets. Contact Customer Service for more information.

 **WARNING:** DO NOT stack ovens more than three high.

It is the operator's responsibility to ensure the oven is properly positioned on countertop. Middleby Marshall will not warrant any damage or injury to ovens that fall off countertops due to improper placement.

Proper placement of the oven will enhance long-term operator convenience and satisfactory performance. Be sure to place the oven in an area accessible for proper operation and servicing.

The surface on which the oven is placed must be at least 30" (762 mm) deep and capable of supporting 200 lb. (90.7 kg) for the PS2020, and 265 lb. (118 kg) for the PS2620 (weights are per oven). The manufacturer shall not assume liability for damage or injury resulting from the improper installation of this equipment including temporary or unstable work stations or countertops.

The oven must be installed level front to back and side to side. For additional stability, the oven legs may be bolted to the countertop if desired.

## Installation Near Open Heat Source

When placing a Middleby Marshall oven near an open heat source (see Figure 11), adhere to the following:

- If the oven is being placed near a grill or stove, a divider must exist between the oven and the open heat source, with a minimum of 6" (152 mm) between the oven and the divider.
- If the oven is being placed near a fryer, a divider must exist between the oven and fryer, with a minimum of 12" (305 mm) between the oven and the divider.
- The height of the divider must be greater than or equal to the height of the oven(s) – 13" (330 mm) without legs or 17" (432 mm) with legs.
- Verify oven location has a minimum 10" (254 mm) clearance on top and minimum

2" (51 mm) of clearance on each side.

## Ventilation Requirements

PS2020/PS2620 should be operated underneath a ventilation hood, except where local laws or codes allow for use without a ventilation hood, unless the oven is a UL®-certified ventless model (available upon request). For more information or to order a ventilation hood, contact 877-346-8367, or your local distributor.

PS2020/PS2620 oven has been approved by Underwriter's Laboratory for ventless operation (UL® KNLZ listing) for all food items except for foods classified as "fatty raw proteins." Such foods include bone-in, skin-on chicken, raw hamburger meat, raw bacon, raw sausage, steaks, etc. If cooking these types of foods, consult local HVAC codes and authorities to ensure compliance with ventilation requirements.

PS2020 and PS2620 is approved for ventless operation while single or double stacked.

To ensure continued compliance with all health, building, and fire codes, you are required to maintain clean and sanitary conditions around your oven at all times.

NOTE: In no event shall the manufacturer assume any liability for damages or injuries resulting from installations which are not in compliance with the instructions and codes previously listed. Failure to comply with these instructions could result in the issuance of a temporary cease and desist order from the local health department until the environment concerns are addressed.

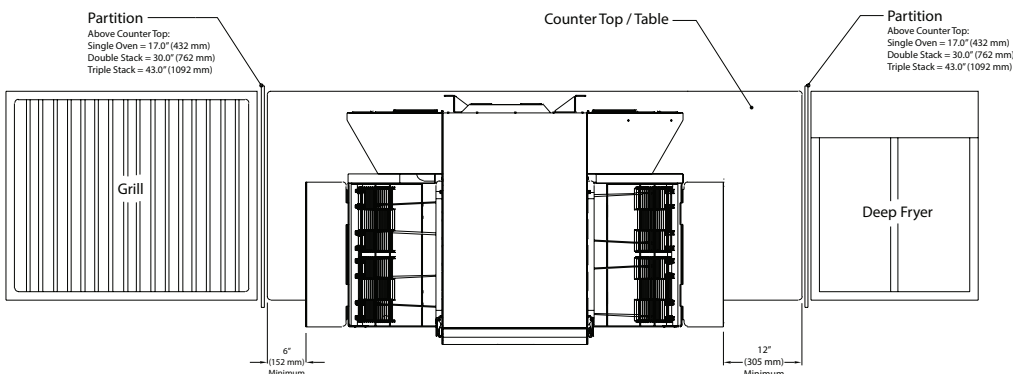







Figure 11: Installation Near Open Heat Source



# Daily Cleaning Instructions

 = Wash, rinse, sanitize.  
(Use only Middleby Marshall-approved cleaner).

 = Completely dry with clean towel.

-  **WARNING:** Always disconnect power before cleaning or servicing oven.
-  **WARNING:** DO NOT attempt to clean the oven until it has cooled (screen reads “Oven Off”).
-  **WARNING:** DO NOT use a water jet when cleaning the oven.

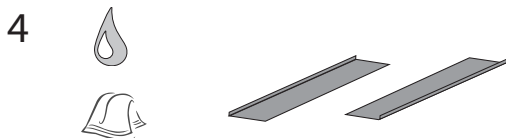
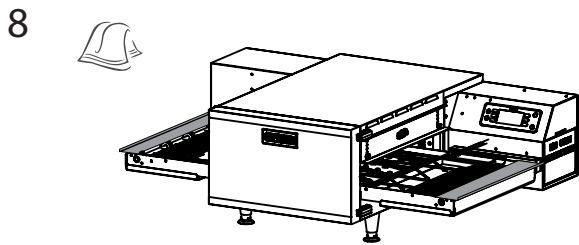
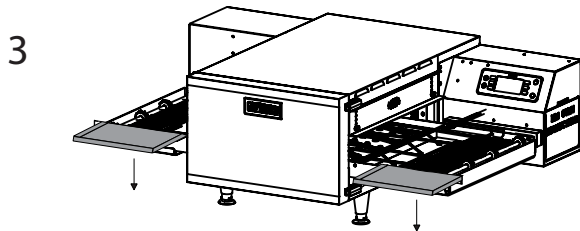
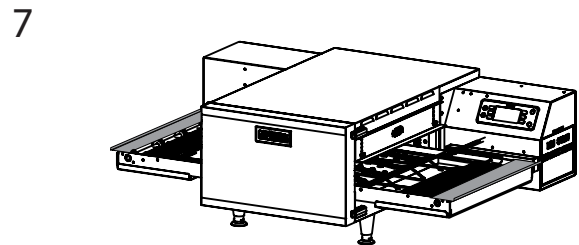
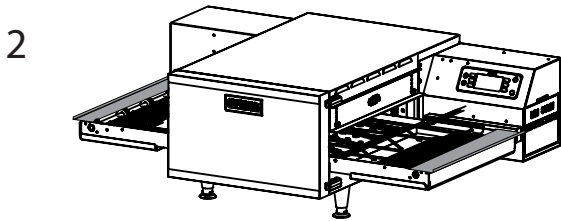
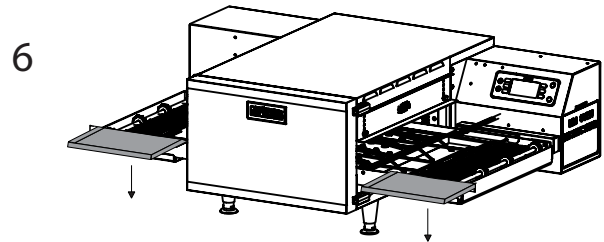
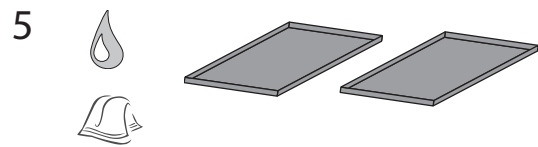
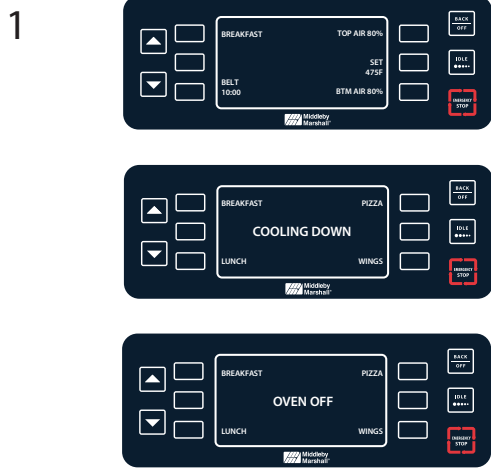

## Weekly Cleaning Instructions



= Wash, rinse, sanitize. (Use only Middleby Marshall-approved cleaner).



= Completely dry with clean towel.



**WARNING:** Always disconnect power before cleaning or servicing oven.



**WARNING:** DO NOT attempt to clean the oven until it has cooled (screen reads “Oven Off”).



**WARNING:** DO NOT use a water jet when cleaning the oven.

### Step 1: Turn the Oven Off

1.

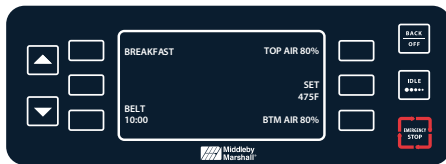

2.

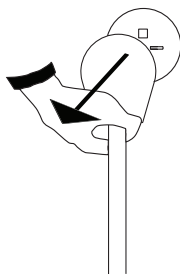

### Step 2: Remove Outer Oven Components

1.

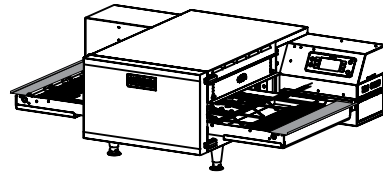

2.

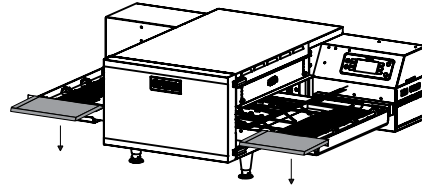

3.

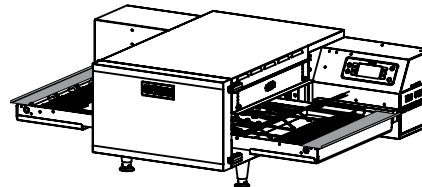

4.

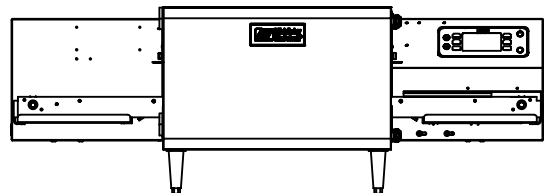

### Step 3: Remove Inner Oven Components

1.



2.



3.

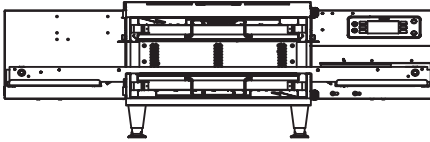

4.

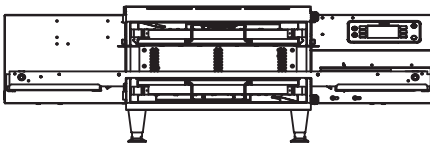

5.



### Step 4: Clean Oven Components

1.

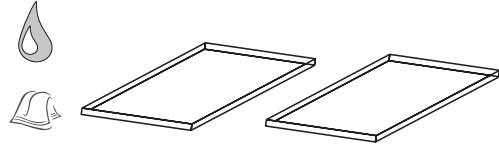

2.

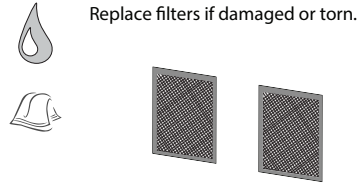

3.

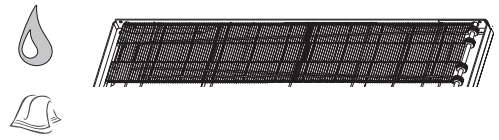

4.

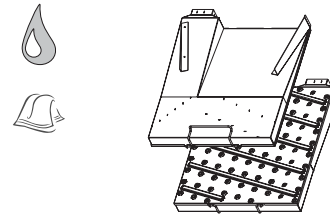

### Step 5: Replace Oven Components

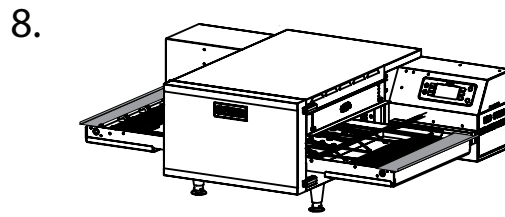
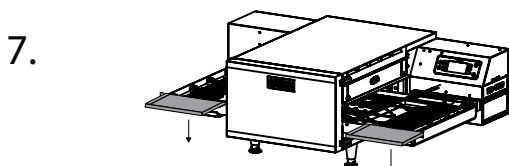
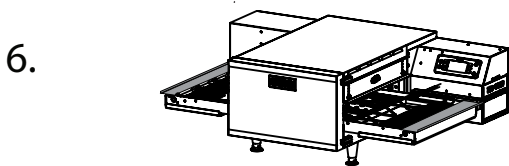
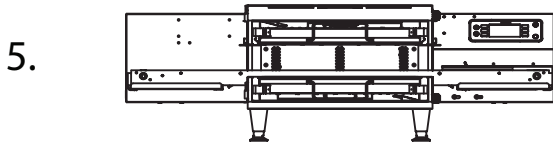
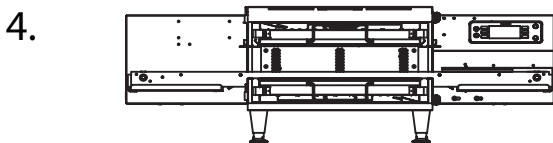
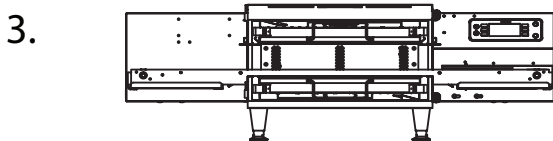
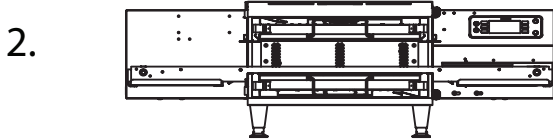
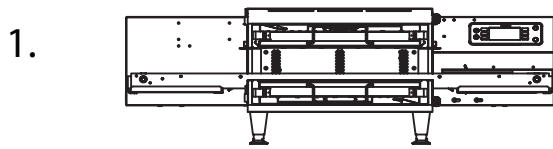

### Step 6: Verify Chain Tension

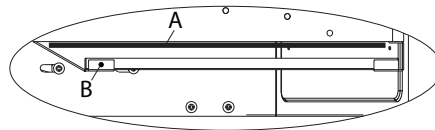
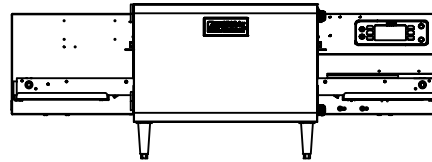

Acceptable - Chain (A) is tight and easily clears crumb tray holder (B)

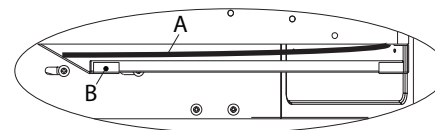

Call service to have link removed - Chain (A) is loose and risks contact with crumb tray holder (B)

### Step 7: Ready the Oven for Use

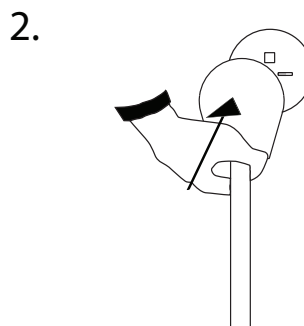
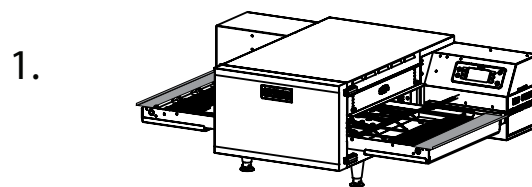



Figure 12: Oven Controls

## Oven Controls

Figure 12.

### 1. Display

The display shows current oven operation and/or user programming information.

### 2. Soft Keys

Six soft keys are on the oven controls, three on the left (L1, L2, L3, where L1 = top) and three on the right (R1, R2, R3, where R1 = top). Use the soft keys to select the option/command that is adjacent to it.

### 3. Up and Down Keys

When the oven is in the OVEN OFF MODE, use the up key to access the CONFIG MODE (page 13). Use the down key to access cooking profiles 5-8.

Also, press the up and down keys to adjust various oven settings (see pages 11-15).

### 4. Back/Off Key

Depending on the mode the oven is in, the back/off key will return the oven to the previous screen or turn the oven off (page 9).

### 5. Idle Key

The idle key activates the IDLE MODE (page 12).

### 6. Emergency Stop Key

The emergency stop key shuts down the conveyor and heaters and returns the oven to the OVEN OFF MODE (page 9).

NOTE: Depending on the temperature within the oven, the cooling fans will remain on to prevent damage to critical oven components.

**⚠ CAUTION: DO NOT** use the emergency stop key as a general on/off switch. Doing so can damage the oven and shorten its life span.

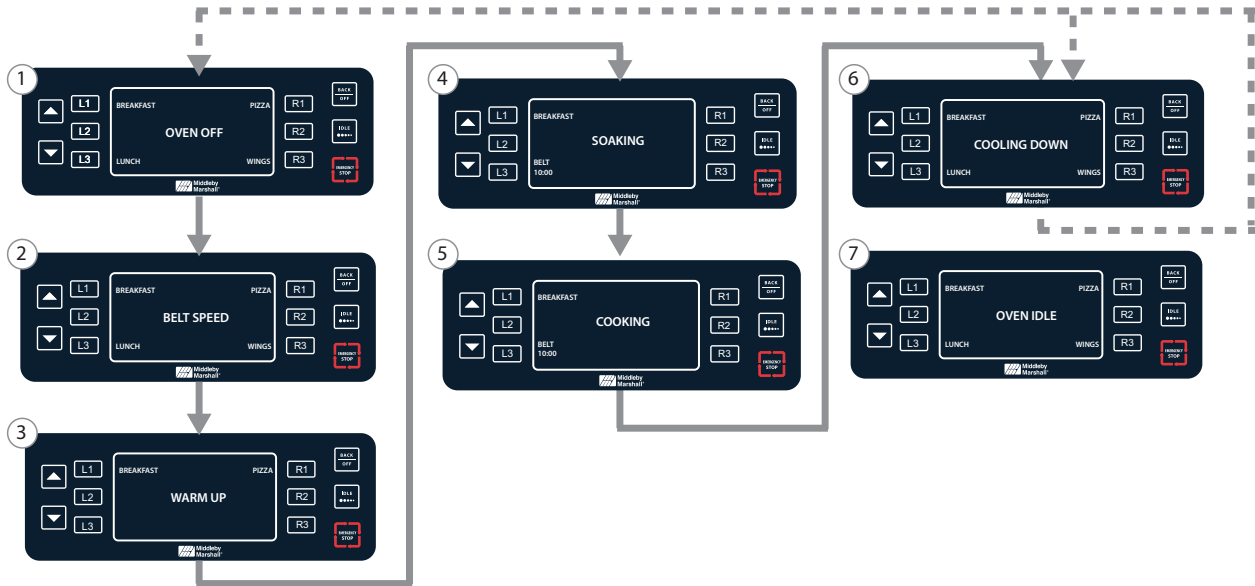

Figure 13: Cooking Modes

## Cooking

Figure 13.

This section explains how to cook a food product by describing the “standard operation” modes through which the oven progresses (Figure 13).

- MODE 1: Oven Off
- MODE 2: Belt Speed Select
- MODE 3: Warming
- MODE 4: Soaking
- MODE 5: Cooking
- MODE 6: Cooling Down
- MODE 7: Idle

NOTE: MODE 7 is not part of a “standard” cooking cycle. It only occurs when the user intervenes as described on page 10.

### Mode 1: Oven Off

Mode during which all cooking components are off and the oven temperature has receded below 150°F (66°C), but the display and keypad remain on. The user can access cooking profiles 1-4 on this screen (1) or press the down key to access cooking profiles 5-8.

Happens When...

- Power is supplied to the oven.
- The oven completes MODE 6.
- The user presses the down key while accessing the CONFIG MODE (refer to page 14 for more information).

Goes To...

- MODE 2 when the user selects a cooking profile (soft keys L1, L3, R1, or R3).
- CONFIG MODE when the user presses the up key.

### Mode 2: Belt Speed Select

Mode during which the user selects the desired belt speed.

NOTE: If a different key is pressed, the oven will ask if you wish to continue or return to the belt speed select screen. If you select continue, the oven will not save the belt speed.

Happens When...

- The user selects a cooking profile from MODE 1 or 6.

Goes To...

- MODE 3.

## Cooking

Figure 13.

This section explains how to cook a food product by describing the “standard operation” modes through which the oven progresses (Figure 13).

- MODE 1: Oven Off
- MODE 2: Belt Speed Select
- MODE 3: Warming
- MODE 4: Soaking
- MODE 5: Cooking
- MODE 6: Cooling Down
- MODE 7: Idle

NOTE: MODE 7 is not part of a “standard” cooking cycle. It only occurs when the user intervenes as described on page 10.

### Mode 1: Oven Off

Mode during which all cooking components are off and the oven temperature has receded below 150°F (66°C), but the display and keypad remain on. The user can access cooking profiles 1-4 on this screen (1) or press the down key to access cooking profiles 5-8.

Happens When...

- Power is supplied to the oven.
- The oven completes MODE 6.
- The user presses the down key while accessing the CONFIG MODE (refer to page 14 for more information).

Goes To...

- MODE 2 when the user selects a cooking profile (soft keys L1, L3, R1, or R3).
- CONFIG MODE when the user presses the up key.

### Mode 2: Belt Speed Select

Mode during which the user selects the desired belt speed.

NOTE: If a different key is pressed, the oven will ask if you wish to continue or return to the

belt speed select screen. If you select continue, the oven will not save the belt speed.

Happens When...

- The user selects a cooking profile from MODE 1 or 6.

Goes To...

- MODE 3.

### Mode 3: Warming

Mode during which the oven warms to the pre-set cooking temperature defined by the cooking profile that was selected.

Happens When...

- A selection is made from MODE 2, and the oven’s temperature at the beginning of warmup was not within (less than) 25°F (14°C) of the oven’s set temperature.

Goes To...

- MODE 4 once the oven has reached the temperature defined by the selected cooking profile.
- MODE 6 when the user presses the back/off key and the oven is above 150°F (66°C).

### Mode 4: Soaking

Mode during which the oven has completed warming up and automatically allows an additional five minutes for the oven cavity surfaces to warm.

Happens When...

- MODE 3 completes (within 5°F [3°C] of set point).

Goes To...

- MODE 5 when soaking completes.
- MODE 6 when the user presses the back/off key and the oven is above 150°F (66°C).

### Mode 5: Cooking

Mode during which the oven is ready to cook. The user can place food on the conveyor to cook, or edit cook settings if the full edit or flex option is enabled. See page 11 for more infor-

## Editing a Cooking Profile

To edit a cooking profile, the oven must be in the COOKING MODE and the full edit or flex option must be enabled for each option to be edited. For more information on selecting between full edit, rigid, and flex options for each editable setting, see Edit Options Screen on page 14.

When the rigid option is enabled for a given setting, the soft key adjacent to that setting (Figure 14) is disabled and no menu editing is allowed.

When the full edit option is enabled for a given setting, that setting is fully customizable and changes are saved once the oven returns to the OVEN OFF or COOLING DOWN MODE.

When the flex option is enabled for a given setting, that setting is customizable within flex option limitations (as described in the following sections), and changes will reset when the oven returns to the OVEN OFF or COOLING DOWN MODE.

NOTE: The flex option does not apply to editing a profile name.

This section assumes that the full edit option is enabled (except where otherwise noted) and that a cooking profile and belt speed have been selected.

## Changing a Cooking Profile Name

- From the cooking screen (Figure 14), press L1 to access the name change screen (Figure 15).
- Change the name of the cooking profile.
  - The up key moves up through the available characters. e.g. A,B,C...
  - The down key moves down through the available characters e.g. A,+,-, ,9,8...
  - INS (L1) inserts a space.
  - DEL (R1) deletes the selected character.
  - ----> (R2) moves the cursor to the right.
  - <---- (L2) moves the cursor to the left.
- Press save (R3) to save the changes or cancel (L3) to cancel any changes.



Figure 14: Cooking Screen

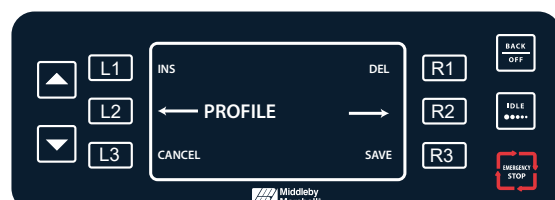

Figure 15: Name Change Screen



### Adjusting the Belt Speed

1. Press the soft key adjacent to the conveyor belt (Figure 14, page 11).
2. Adjust the time it takes for the conveyor belt to completely cycle through the oven.
  - The up key increases bake time in 5-second increments up to 15 minutes.
    - + Flex option enabled: the user can only increase the time up to an additional 15 seconds.
  - The down key decreases bake time in 5-second increments.
    - + Flex option enabled: the user cannot decrease the time by more than 15 seconds.
3. Press the soft key adjacent to the belt to exit the belt speed controls.

### 2. Adjust the air speed.

- Press the up key to increase the air speed in 5% increments up to 100%.
  - + Flex option enabled: the user can only increase the air speed by up to an additional 15%.
- Press the down key to decrease the air speed in 5% increments down to 30%.
  - + Flex option enabled: the user cannot decrease the air speed by more than 15%.
- Press the soft key again to exit the air controls.

### Adjusting the Temperature

1. Press R2 (Figure 14, page 11) to access the temperature controls.
2. Adjust the temperature (range is 300°F-550°F [149-288°C]).
  - Press the up key to increase the temperature in 5°F/5°C increments.
    - + Flex option enabled: the user can only increase the temperature up to an additional 10°F/5°C.
  - Press the down key to decrease the temperature in 5°F/5°C increments.
    - + Flex option enabled: the user cannot decrease the temperature by more than 10°F/5°C.
3. Press R2 again to exit temperature controls.

### Adjusting the Top and Bottom Air

1. Press R1 or R3 (Figure 14, page 11) to access the air controls.

## Config Mode

The CONFIG MODE (Figure 16) serves four main purposes:

1. To access the smart card screen.
2. To access the fault count screen.
3. To access the SETUP MODE.
4. To access the TEST MODE (service use only).

To access CONFIG MODE, press the up key from the OVEN OFF MODE.

### Smart Card Screen (Loading a Menu)

- The smart card screen allows the user to
- Load a menu from smart card to oven.
  - Save a menu from oven to smart card.

To load or save a menu,

1. Press L3 (Figure 16) to access the smart card screen (Figure 17).
2. Insert a smart card into the smart card slot (Figures 18 and 19), with the gold chip facing the front of the oven.
3. Load or save a menu.
  - Press R1 to load a menu from the smart card to the oven (Figure 17).
  - Press R2 to save a menu from the oven to the smart card (Figure 17).

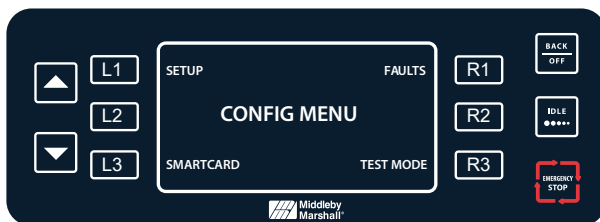

Figure 16: Config Mode



Figure 17: Smart Card Screen

### Accessing the Fault Count Screen

From the CONFIG MODE (Figure 16), press R1 to access the fault counts screen (Figure 20, page 14). The oven will display the number of faults that have occurred.

### Accessing the Setup Mode

From the CONFIG MODE (Figure 16), press L1 to access the SETUP MODE. The SETUP MODE allows the user to customize several oven settings – see below for more details.

## Setup Mode

Figure 21, page 14.

The SETUP MODE serves four main purposes:

1. To change the display temperature.
2. To access the edit option screen.
3. To change the display language.
4. To access the info screen.

To access SETUP MODE, press the up key from the OVEN OFF or COOLING DOWN MODE (to access the CONFIG MODE), and then press L1.

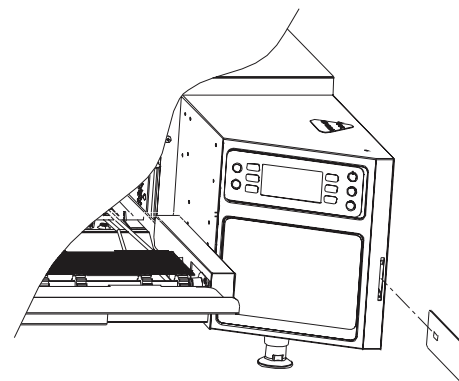

Figure 18: Loading a Smart Card



Figure 19: Insert Smart Card Screen

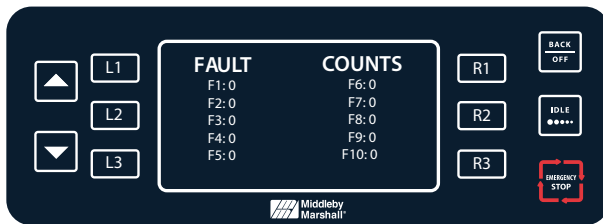

Figure 20: Fault Counts Screen

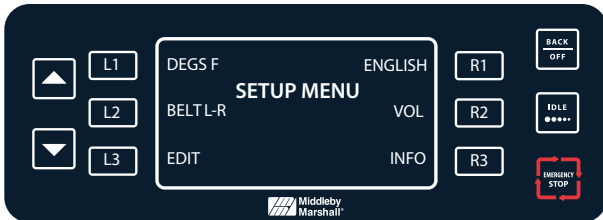

Figure 21: Setup Mode



Figure 22: Password Screen

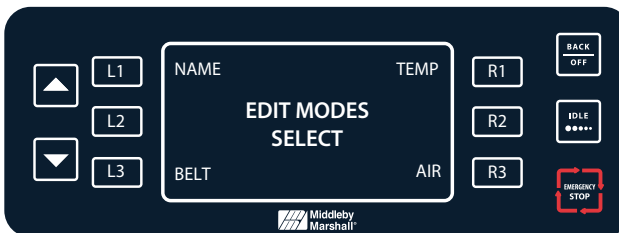

Figure 23: Edit Option Screen



Figure 24: Info Screen

## Changing the Display Temperature

The oven can display the temperature in either Celsius or Fahrenheit units. To change the display temperature, press L1 in SETUP MODE (Figure 21).

## Changing the Belt Direction

The oven's belt(s) can travel from left to right or right to left. To change the belt direction, press L2 in SETUP MODE (Figure 21).

## Edit Options Screen

The edit options screen (Figure 23) allows the user to switch between full edit, rigid, and flex options for profile name, belt speed, temperature, and % air. For more information on the different edit options, see *Editing a Cooking Profile* on page 11.

To access the edit options screen,

1. Press L3 (Figure 21) to access the password screen (Figure 22).
2. Input the password 6 6 3 3 by pressing the soft keys adjacent to the numbers.

To change the edit option (Figure 23),

- Press L1 to select full edit or rigid for the profile name.
- Press L3 to select full edit, rigid, or flex for the belt speed.
- Press R1 to select full edit, rigid, or flex for the profile cook temperature setting.
- Press R3 to select full edit, rigid, or flex for the % air setting.

## Changing the Speaker Volume

Press R2 (Figure 21) to change the volume of the speaker. The volume can be set to either 0, 1, 2, or 3 (where 0 is mute and 3 is the loudest setting).

## Info Screen

The info screen (Page 14) is used to display the following information in an easy to access place:

- Serial number
- Electrical compartment temperature
- Voltage
- Total time the oven has been on
- Total time the oven has been idle
- Firmware version

To access the info screen, press R3 within the SETUP MODE (Page 14).

## Updating the Firmware

From the oven off screen,

1. Insert the gray smart card (see Figure 25) with the gold chip facing the front of the oven. If multiple smart cards are required, they will be labeled in sequence – ensure the correct sequence is followed.
2. From the COOLING DOWN or OVEN OFF MODE, press and hold the idle key until the oven resets (approximately 5 seconds). The display will go blank until the upload is complete.
3. When the oven beeps one long high tone, the load was successful. If a second card was provided, insert it and repeat steps 1-3.
4. Remove the smart card from the oven. The oven will restart.

NOTE: If the update is unsuccessful, the display will remain off and the oven will beep one long, low tone. If this occurs, repeat the above procedure. If the update fails multiple times, a smart card may be damaged. Please note that the oven will be inoperable until a successful update is performed. As such, Middleby Marshall reinforces proper handling of smart cards to help prevent static damage, and recommends that each service technician keep a backup copy.

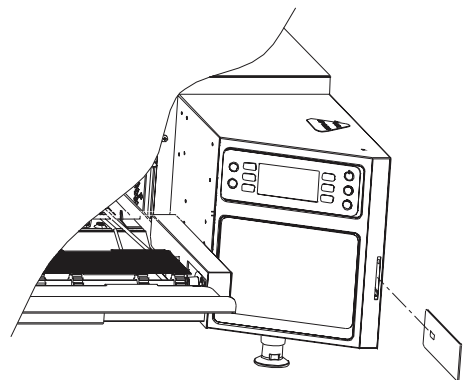

Figure 25: Updating Firmware

## Troubleshooting

The following is a list of fault codes and error messages, along with the possible problem(s) that the oven may experience. Please attempt the recommended action before calling Customer Support (800-908-8726) or your Authorized Distributor.

If any fault or error message occurs that is not listed below, contact Middleby Marshall Customer Support (800-908-8726).



**WARNING:** Food and oven cavity are hot! Use extreme caution when troubleshooting the issues below.

Issue	Possible Cause(s)	Resolution
No power to oven.	<ul style="list-style-type: none"> <li>- Oven is not plugged in.</li> <li>- Main circuit breaker is tripped.</li> </ul>	<ul style="list-style-type: none"> <li>- Plug oven in.</li> <li>- Verify wall circuit breaker is on. Reset breaker and then power oven back on.</li> </ul>
Oven is not warming up properly.	<ul style="list-style-type: none"> <li>- Oven is in the off state.</li> <li>- Oven has been switched off at the main circuit breaker.</li> <li>- Oven display is in Celsius.</li> <li>- Problem with the heater.</li> </ul>	<ul style="list-style-type: none"> <li>- Select a cooking profile.</li> <li>- Press the back/off key until the oven is in the off state – leave for two minutes. Unplug the oven – leave for two minutes. Re-plug in the oven, switch on the isolator/main power supply and select a cooking profile.</li> <li>- Change back to Fahrenheit (page 14).</li> <li>- Call customer service.</li> </ul>
Oven is not cooking properly	<ul style="list-style-type: none"> <li>- Oven is not clean.</li> <li>- Cook settings were changed.</li> <li>- Incorrect cooking profile or belt speed was selected for the product.</li> <li>- Product was not cooked from correct starting state, e.g. chilled, frozen, etc.</li> </ul>	<ul style="list-style-type: none"> <li>- Clean the oven following the weekly cleaning instructions on pages 4-7</li> <li>- Confirm correct settings (page 11 and 12).</li> <li>- Ensure that the correct cooking profile is selected for the product.</li> <li>- Ensure product is in the correct state before being placed in the oven.</li> </ul>
	<ul style="list-style-type: none"> <li>- Oven power interrupted.</li> </ul>	<ul style="list-style-type: none"> <li>- Verify wall circuit breaker is on. Reset breaker and then power the oven back on. Press the back/off key until the oven is in the off mode – leave for two minutes. Unplug the oven – leave for two minutes. Re-plug in the oven, switch on the isolator/main power supply and select a cooking profile.</li> </ul>

Issue	Possible Cause(s)	Resolution
F2: Low Temp During Cook	<ul style="list-style-type: none"> <li>- Oven power interrupted.</li> <li>- Excessive load.</li> <li>- Oven is not clean.</li> <li>- Oven not fully warmed up.</li> <li>- Defective heater.</li> <li>- Blower motor not running.</li> <li>- Low supply voltage.</li> </ul>	<ul style="list-style-type: none"> <li>- Verify wall circuit breaker is on. Reset breaker and then power oven back on.</li> <li>- Reduce load.</li> <li>- Clean the oven following the weekly cleaning instructions on pages 4-7.</li> <li>- Press the back/off key until oven returns to the oven off mode. Re-select the cooking profile and allow oven to reheat.</li> <li>- Call customer service.</li> <li>- Call customer service.</li> <li>- Call electrician to improve power supply.</li> </ul>
F5: CC Over Temp	<ul style="list-style-type: none"> <li>- Blockage of airflow into the oven.</li> <li>- Problem with the blower motors or heater.</li> <li>- Defective SSR.</li> </ul>	<ul style="list-style-type: none"> <li>- Check for and remove anything that may be obstructing regular airflow into the oven.</li> <li>- Call customer service.</li> <li>- Call customer service.</li> </ul>
F6: EC Over Temp	<ul style="list-style-type: none"> <li>- Blockage of airflow into the electrical compartment.</li> <li>- Problem with the cooling fans.</li> </ul>	<ul style="list-style-type: none"> <li>- Check for paper towels or anything that may be obstructing cool air into the electrical compartment.</li> <li>- Call customer service.</li> </ul>
F7: RTD Failure	<ul style="list-style-type: none"> <li>- Damaged or defective oven components.</li> </ul>	<ul style="list-style-type: none"> <li>- Call customer service.</li> </ul>
F8: High Limit Tripped	<ul style="list-style-type: none"> <li>- Oven is not clean.</li> </ul>	<ul style="list-style-type: none"> <li>- Clean the oven following the weekly cleaning instructions on pages 7-9. If problem persists, call customer service.</li> </ul>
F9: Belt Run Failure	<ul style="list-style-type: none"> <li>- Too much weight on belt.</li> <li>- Obstruction blocking belt rotation.</li> <li>- Damaged or defective oven components.</li> <li>- Overheated conveyor drives</li> </ul>	<ul style="list-style-type: none"> <li>- Ensure oven is in the off state and completely cooled and belt is completely stopped. If belt is overloaded, remove product from belt.</li> <li>- Ensure oven is in the off state and completely cooled and belt is completely stopped. Look into oven cavity and remove any obstructions that are blocking the belt's rotation.</li> <li>- Call customer service.</li> <li>- Ensure the filters are clean and fans are running. Also ensure ambient temperature is not excessive (greater than 100°F [38°C]).</li> </ul>

## Replaceable Parts

The following is a list of parts that may need replacing during the life of the oven. For more information, please contact Middleby Marshall. Call 877-34-OVENS or your authorized distributor.

Part Description	Middleby Marshall Part Number
Air Filter	MMC-7393
Blower Motor	HCT-3022
Blower Motor Controller (BMSC)	CON-3010
Control Board	CON-3012-1
Cooling Fan	TC3-0433
Display	CON-7107
EMI Filter	105455
Fuse, 20A	100599
Gear Drive	HHC-4120
Keypad	MMC-9524
Power Supply	105190
Relay, K3, 30A	101279
Relay, SSR	HCT-4354
RTD Probe, 3-Inch	HHC-6595

# North America Limited Warranty

The Limited Warranty outlined below for the Middleby Marshall conveyor oven (model PS2020) is activated upon shipment of your oven. Should you require additional assistance after reviewing the warranty outlined below, please call Middleby Marshall Customer Service at 800-908-8726.

## Limited Warranty

Middleby Marshall Inc. warrants to you, the purchaser, that under normal use the Middleby Marshall PS2020 Conveyor oven you have purchased (the "Equipment") will be free from defects in material and workmanship during the Warranty Period, subject to the terms and conditions set forth herein. The "Warranty Period" is twelve (12) months from the date the Equipment is shipped from Middleby Marshall's U.S. factory or distribution center. This warranty is conditioned upon you promptly notifying Middleby Marshall of any claims, as provided in the paragraph entitled "Warranty Claims" below, and providing Middleby Marshall with all data and information requested by Middleby Marshall or its service agents in connection with such claims as well as all necessary access to your premises and the Equipment. This warranty is made only to the initial purchaser of the Equipment from Middleby Marshall or its authorized dealer; it is not assignable to subsequent purchasers unless Middleby Marshall consents to such assignment in writing.

## Disclaimer of Warranties

EXCEPT AS PROVIDED IN THE LIMITED WARRANTY ABOVE, THE EQUIPMENT IS PROVIDED "AS IS". THERE ARE NO WARRANTIES, EXPRESS, IMPLIED OR STATUTORY, WHICH EXTEND BEYOND THE DESCRIPTION ON THE FACE HEREOF INCLUDING ANY IMPLIED WARRANTY OF MERCHANTABILITY AND/OR FITNESS FOR A PARTICULAR PURPOSE AND/OR ANY IMPLIED WARRANTY OF NON-INFRINGEMENT. THIS LIMITED WARRANTY GIVES YOU SPECIFIC LEGAL RIGHTS WHICH MAY VARY DEPENDING UPON THE LAW OF YOUR STATE OR COUNTRY.

## Warranty Exclusions

**Improper Installation, Operation or Maintenance:** Equipment that is not installed, operated and maintained in accordance with the Equipment's owner's manual (as may be updated by Middleby Marshall from time to time, the "Manual"), a copy of which is provided to you with the Equipment or otherwise will be furnished to you upon request, is excluded from this limited warranty. This limited warranty shall not apply to damage to the product which results, in Middleby Marshall's or its service agent's sole opinion, due to any of the following causes: failure to provide a suitable installation and operating environment (including power and HVAC) and facilities as prescribed by the Manual; misuse; abuse; accident; neglect; power failure or power surges (over or under voltage); flood, fire, lightning, other natural or man-made disasters, or other Acts of God. This limited warranty shall not apply to Equipment that has missing or altered serial numbers.

**Conveyor Damage:** Damage to the Equipment conveyor bed, chain(s), and belt(s) caused by external sources is not covered under this warranty.



**Modifications and Repair:** Equipment that has been modified or altered by persons other than Middleby Marshall or its service agents, or Equipment that has had non-approved devices or connection items attached thereto, is excluded from coverage under this warranty. Repair of the Equipment by anyone other than Middleby Marshall or its authorized service agents will void all warranties on the Equipment.

**Accessories:** Accessories and parts (collectively “Accessories”) that are consumed in the normal course of Equipment operation or maintenance are excluded from this warranty. Failure of or damage to Equipment or components from the use of non-approved cleaning chemicals, devices or processes is also excluded from this warranty. Accessories may include, but are not limited to, ceramic cooking platters, paddles and approved cleaning chemicals and devices.

**Outstanding Invoices:** If the full invoiced amount for Equipment purchased has not been paid within forty-five (45) days from the invoice date, then Middleby Marshall will have no obligation to honor this or any other warranty on the Equipment until payment is received in full, including any accrued interest or other charges, has been satisfied, at which time warranty coverage will be reinstated, but the Warranty Period will not be extended.

#### **Warranty Service, Exclusive Remedy**

Middleby Marshall will be solely responsible for determining whether or not the Equipment or any component thereof is defective. Defective components covered by this warranty will be repaired or replaced at Middleby Marshall’s option without charge to you and such repaired or replacement components will be covered by this warranty for the balance of the Warranty Period. Parts used in the repair of defective components and replacement components may be new, recovered or rebuilt. At its sole option, Middleby Marshall may decide to replace defective Equipment covered by this warranty with new, recovered or rebuilt Equipment of equal or greater capability, and such Equipment will be covered by this Limited Warranty for the balance of the Warranty Period. Defective Equipment and components will become the property of Middleby Marshall. This paragraph states Middleby Marshall’s sole and exclusive obligation and liability and your sole and exclusive remedy under this warranty. Middleby Marshall shall not be responsible for a failure to provide warranty services due to causes beyond Middleby Marshall’s or its service agents’ control.

#### **Warranty Claims**

Claims under this warranty must be reported to Middleby Marshall during our normal working hours at the following number: 800-908-8726, or such other reporting service as Middleby Marshall may designate. Upon receipt of the claim and related information and preliminary verification that the claim is valid, Middleby Marshall will promptly notify an authorized service agent to contact you and arrange for an on-site repair visit during the service agent’s normal working hours. Any costs incurred by Middleby Marshall or its service agent associated with a service agent being refused or unable to gain access to the Equipment on your premises, or a claim not covered by this warranty, will be charged to you.

#### **Charges for Non-Warranty Service or Rejection of Service Visit**

In the event that repairs, replacement or service are provided by Middleby Marshall’s service agents for work not covered by this limited warranty, customer agrees to pay the service agent directly according to the service agent’s normal scale of charges. In the event Middleby Marshall is invoiced by the service agent for services not covered under this limited warranty, Middleby

Marshall will invoice customer and customer will pay such invoice based on terms of net 10 days. Customer also agrees to pay any cost incurred by Middleby Marshall or its service agent associated with a service agent responding to a call for service, but then being refused or unable to gain access to the Oven on Customer's premises. Failure to submit payment may, at Middleby Marshall's discretion, result in Middleby Marshall voiding the balance of the warranty. In no event will Middleby Marshall authorize service to a store with an outstanding Non-Warranty invoice.

#### Disclaimer of Damages

MIDDLEBY MARSHALL DISCLAIMS ALL INCIDENTAL, SPECIAL AND CONSEQUENTIAL DAMAGES, INCLUDING BUT NOT LIMITED TO, LOSS OF USE, LOST REVENUE OR PROFITS, OR SUBSTITUTE USE, SUFFERED BY YOU OR ANY THIRD PARTY, WHETHER ARISING IN CONTRACT, TORT (INCLUDING NEGLIGENCE), OR OTHERWISE, RESULTING FROM ANY BREACH BY Middleby Marshall OR ITS SERVICE AGENTS OF THIS LIMITED WARRANTY, OR RESULTING FROM THE MANUFACTURE, USE, OR DEFECTS, OF OR IN THE EQUIPMENT, EVEN IF Middleby Marshall WAS APPRISED OF THE POSSIBILITY OF SUCH DAMAGES. SOME STATES AND COUNTRIES DO NOT ALLOW THE EXCLUSION OF INCIDENTAL OR CONSEQUENTIAL DAMAGES, SO THE ABOVE LIMITATION MAY NOT APPLY TO YOU.

#### Customer Indemnity

You agree to indemnify, defend and hold Middleby Marshall harmless from all third party claims, demands, judgments, fees and costs directly or indirectly arising out of or related to your use of the Equipment. You further agree to indemnify and hold Middleby Marshall harmless from any incidental, consequential or special damages suffered by you, including lost revenue or profits, loss of use, or substitute use, during periods of Equipment failure or loss of use.

#### Territory

This warranty is valid in the United States of America, Canada and Puerto Rico.

#### Governing Law, Entire Warranty

This warranty shall be governed and construed in accordance with the laws of the State of Texas, USA (except with respect to its provisions regarding conflicts of laws). The warranty described herein is the complete and only warranty for Equipment and supersedes all prior oral or written agreements and understandings that may have existed between us relating to Equipment warranties. The terms of this warranty may not be altered, amended or modified except by a signed writing from Middleby Marshall. Any purported alteration, amendment or modification by a service agent or anyone else will not be enforceable against Middleby Marshall.

#### Waiver

Waiver by Middleby Marshall of any default will not be deemed a continuing waiver of such default or a waiver of any other default.

# International Limited Warranty

This Limited Warranty shall apply to the sales of the Middleby Marshall PS2020 Conveyor oven (the “Equipment”) manufactured by Middleby Marshall Inc. (“Middleby Marshall”), and sold to purchasers outside of the United States, Canada, and Puerto Rico by an Authorized Distributor of Middleby Marshall International (the “Authorized Distributor”).

## Limited Warranty

You, the purchaser (“You”) have entered into a sales contract with the Authorized Distributor for the purchase of the Equipment. This Limited Warranty is made to you by the Authorized Distributor from whom you purchased the Equipment with the support of Middleby Marshall. Subject to the limitations stated below, the Authorized Distributor warrants to You that the quantity and specification of the Equipment delivered to You shall be as set out in the Authorized Distributor’s acceptance of your order and that the Equipment will be free from any material defects in the product and workmanship for twelve (12) months from the date of installation (the “Warranty Period”), subject to the terms and conditions set forth herein.

## Disclaimer

EXCEPT AS PROVIDED IN THE LIMITED WARRANTY ABOVE, THE EQUIPMENT IS PROVIDED “AS IS”. THERE ARE NO WARRANTIES, EXPRESS, IMPLIED, COMMON LAW OR STATUTORY, WHICH EXTEND BEYOND THE DESCRIPTION ON THE FACE HEREOF INCLUDING ANY IMPLIED WARRANTY OF MERCHANTABILITY AND/OR FITNESS FOR A PARTICULAR PURPOSE AND/OR ANY IMPLIED WARRANTY OF NON-INFRINGEMENT. THIS LIMITED WARRANTY GIVES YOU SPECIFIC LEGAL RIGHTS WHICH MAY VARY DEPENDING UPON THE LAW OF YOUR STATE OR COUNTRY.

## The Middleby Marshall Global Warranty System

This Limited Warranty commences upon delivery of the Equipment to Your premises. The Authorized Distributor will inspect and install the Equipment at Your premises in accordance with Middleby Marshall’s instructions and will record the serial number of the Equipment, Your contact details, the date and location of installation and the results of the Authorized Distributor’s inspection. This information will be entered by the Authorized Distributor into the Middleby Marshall global warranty system and will be used by Middleby Marshall, the Authorized Distributor and its authorized service agents for the provision of the warranty service.

## Warranty Service

During the Warranty Period, any materially defective Equipment will be repaired or replaced free of charge at Middleby Marshall’s option provided that:

1. You notify the Authorized Distributor from whom You purchased the Equipment and/or Middleby Marshall as soon as reasonably possible after discovery of a defect and in accordance with the warranty claims procedure set out below;
2. You provide the Authorized Distributor from whom You purchased the Equipment and/or

Middleby Marshall with all data and information reasonably requested by Middleby Marshall, the Authorized Distributor or its authorized service agents in connection with Your warranty claim;

3. You make the Equipment available to Middleby Marshall, the Authorized Distributor or its authorized service agents;
4. The Equipment has been installed by an Authorized Distributor and you have provided all necessary information for the Authorized Distributor to register the Equipment in the Middleby Marshall global warranty system;
5. The Equipment has been operated and maintained by You in accordance with Middleby Marshall's "Owner's Manual" provided with the Equipment (and as updated by Middleby Marshall);
6. You have not used any non-approved devices, accessories, consumables or parts in conjunction with the Equipment; and
7. Repairs, modifications or alterations have not been attempted other than by Middleby Marshall, an Authorized Distributor or its authorized service agent.

Neither Middleby Marshall nor the Authorized Distributor assumes any liability for damage caused, in Middleby Marshall's, its Authorized Distributor's or its service agent's sole opinion, by any of the following: Your failure to provide a suitable installation and operating environment (including power and HVAC) or facilities as prescribed by the Manual; misuse or abuse; accident; neglect; power failure or power surges (over or under voltage); Acts of God; lightning, floods, or other natural disasters; fire; or man-made disasters. This limited warranty shall not apply to Equipment that has missing or altered serial numbers.

At its sole option, Middleby Marshall may replace defective Equipment or components with new, recovered or rebuilt Equipment of equal or greater capability, and such Equipment or components will be warranted by the Authorized Distributor for the balance of the Warranty Period. Replaced defective Equipment or components will become the property of Middleby Marshall.

#### **Warranty Claims**

Any warranty claim must be made directly in writing either to the Authorized Distributor from whom You purchased the Equipment or to Middleby Marshall at the following address:

Middleby Marshall  
1400 Toastmaster Drive  
Elgin, IL 60120  
Phone: 877-346-8367

The claim must include the serial number of the Equipment and be received by Middleby Marshall on or before the last day of the Warranty Period. Upon receipt of Your claim, Middleby Marshall will promptly notify an Authorized Distributor or an authorized service agent to contact You, to verify Your claim and, if necessary, to arrange for an on-site repair visit during normal working hours.

**Conveyor Damage:** Damage to the Equipment conveyor bed, chain(s), and belt(s) caused by external sources is not covered under this warranty.

**Consumables and Parts Used with The Equipment:** Neither Middleby Marshall nor the Authorized Distributor assumes any liability for consumables and parts that are used in the normal course of Equipment operation or for failure of or damage to Equipment or components from the use of non-approved cleaning chemicals, devices or processes.

**Charges for Service Not Covered by Limited Warranty:** In the event that You request and receive repairs, replacement or service not covered by this Limited Warranty, You will be invoiced and must pay the Authorized Distributor or authorized service agent directly according to its normal scale of charges and business terms.

**Product Liability:** NEITHER Middleby Marshall NOR THE AUTHORIZED DISTRIBUTOR ASSUMES ANY LIABILITY FOR ANY INCIDENTAL, SPECIAL OR CONSEQUENTIAL DAMAGES, INCLUDING BUT NOT LIMITED TO LOSS OF USE, LOST REVENUE OR PROFITS, OR SUBSTITUTE USE SUFFERED BY YOU OR ANY THIRD PARTY, WHETHER ARISING IN CONTRACT, TORT (INCLUDING NEGLIGENCE), OR OTHERWISE RESULTING FROM ANY BREACH BY Middleby Marshall OR THE AUTHORIZED DISTRIBUTOR OF THE LIMITED WARRANTY PROVIDED HEREIN, EVEN IF Middleby Marshall AND/OR THE AUTHORIZED DISTRIBUTOR WERE APPRISED OF THE POSSIBILITY OF SUCH DAMAGES. THIS LIMITED WARRANTY GIVES YOU SPECIFIC LEGAL RIGHTS, AND YOU MAY ALSO HAVE OTHER RIGHTS THAT VARY FROM COUNTRY TO COUNTRY. SOME COUNTRIES MAY NOT ALLOW THE EXCLUSION OR LIMITATION OF INCIDENTAL OR CONSEQUENTIAL DAMAGES, MAY NOT ALLOW LIMITATIONS ON HOW LONG AN IMPLIED WARRANTY OR CONDITION LASTS, OR ALLOW PROVISIONS THAT PERMIT THE WARRANTY TO BE VOIDED. THUS, SOME OF THE ABOVE LIMITATIONS OR EXCLUSIONS MAY NOT APPLY TO YOU.

**Exclusive Remedy:** This Limited Warranty states the Authorized Distributors and Middleby Marshall's sole and exclusive obligation and liability and your sole and exclusive remedy under this Limited Warranty.

**Third Party Rights:** The UK Contract (Rights of Third Parties) Act 1999 is excluded from applying to this Limited Warranty and nothing herein confers or purports to confer on any third party any benefit or any right to enforce any term of this Limited Warranty.

**Severability:** If any item or provision contained in this Limited Warranty or any part of them ("an offending provision") is declared to be or becomes unenforceable, invalid or illegal for any reason whatsoever in any jurisdiction, the other terms and provisions of this Limited Warranty shall remain in full force and effect in that jurisdiction as if it had been executed without the offending provision appearing in it and the entire Limited Warranty shall remain in full force and effect in all other jurisdictions.

**Governing Law, Entire, Agreement:** This Limited Warranty shall be governed by and construed according to English law. The application of the United Nations Convention on International Sale of Goods to this Limited Warranty is expressly excluded. This Limited Warranty may not be altered, amended or modified by the Authorized Distributor or its service agent, and no representation, alteration, amendment or modification by Middleby Marshall shall be valid unless in a signed form from Middleby Marshall.

**Waiver:** Waiver by Middleby Marshall or an Authorized Distributor of any default will not be deemed a continuing waiver of such default or a waiver of any other default.

**For service or information:  
Customer Support at 1-877-346-8367**



Global Operations  
1400 Toastmaster Drive  
Elgin, IL 60120  
1-847-741-3300

Customer Support:  
1-877-346-8367  
[www.middlebymarshall.com](http://www.middlebymarshall.com)